



+91-8048006982

# Esc Works Private Limited

<https://www.indiamart.com/escworks/>

We “ESC Works Private Limited” are a renowned service provider affianced in providing highly reliable CAD Services, Reverse Engineering Services, CAD Migration Services, Finite Element Analysis Services, Animation Services, etc.

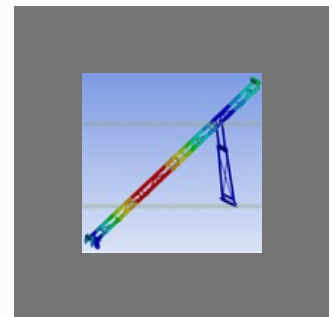
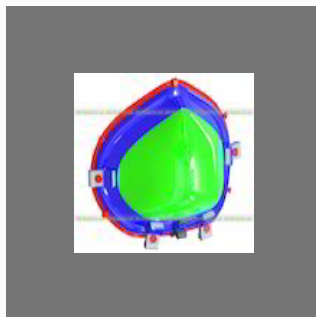

## About Us

We “**ESC Works Private Limited**” are a renowned **service provider** affianced in providing highly reliable **CAD Services, Reverse Engineering Services, CAD Migration Services, Finite Element Analysis Services, Animation Services**, etc. Founded in the year **2013** at **Ahmedabad (Gujarat, India)**, we were established with a motto of providing the best-in-class services in accordance with industry set standards and guidelines. Managed under the headship of, “**Mr. Sunil Prajapati**”, we have been successful in gaining trust of our respected clients.

**For more information, please visit**

<https://www.indiamart.com/escworks/profile.html>



# PRODUCT DESIGN SERVICES

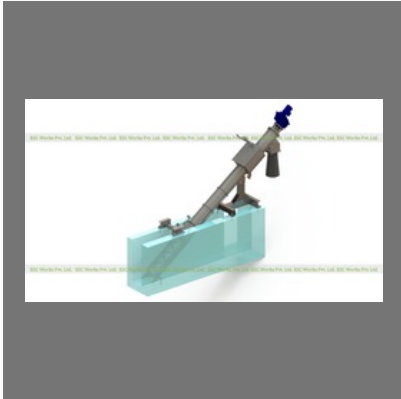

Equipment Design Services

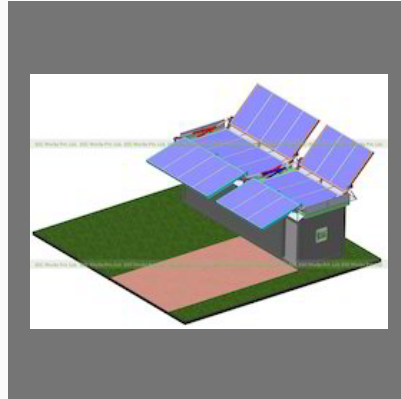

Structural Engineers Service



Product Design Services

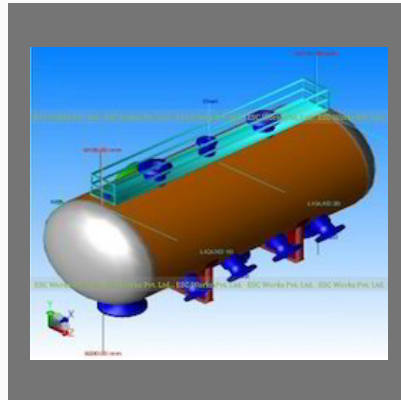

Pressure Vessel Designing Service

# CAD SERVICES

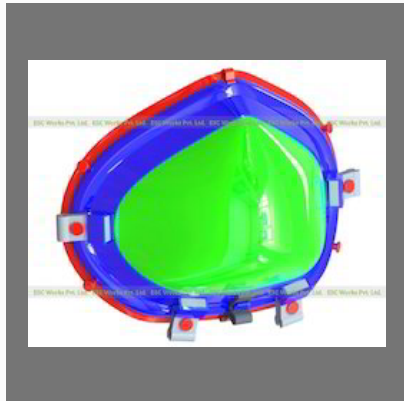

CAD Consultancy Services

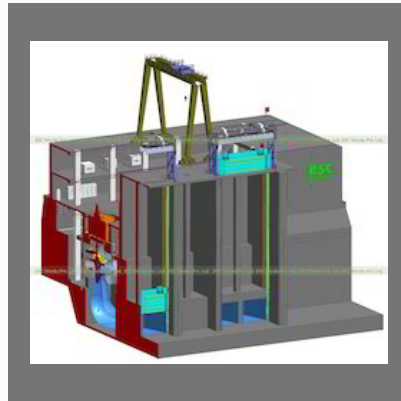

3D CAD Modeling Services

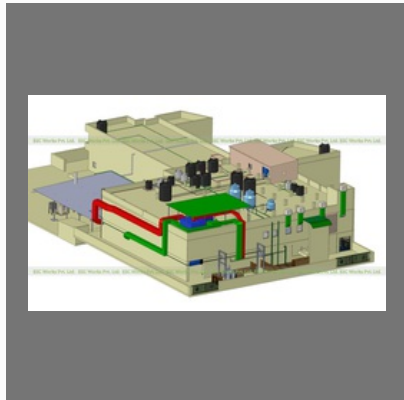

3D Drawing Services

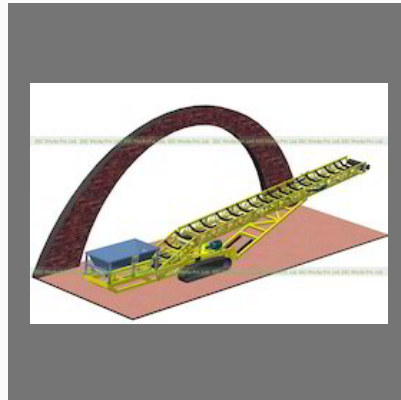

CAD Services

# FINITE ELEMENT ANALYSIS SERVICES

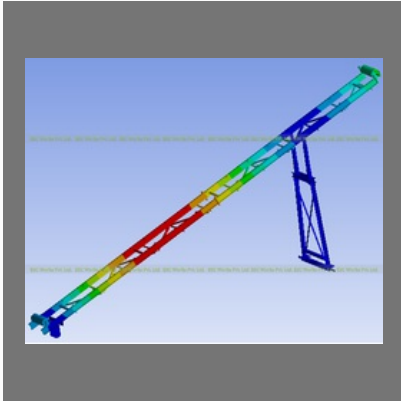

Static Stress Analysis Services

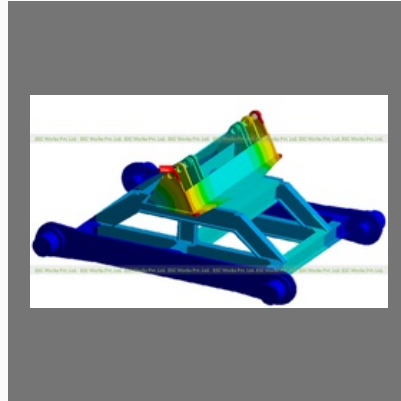

Fatigue Analysis Services

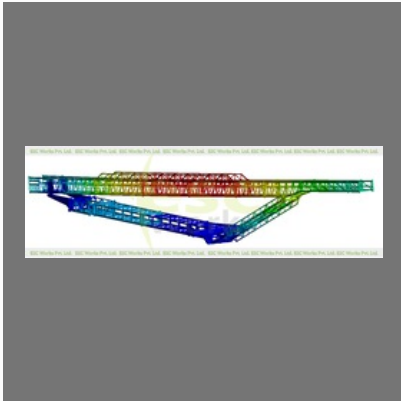

Finite Element Analysis Services

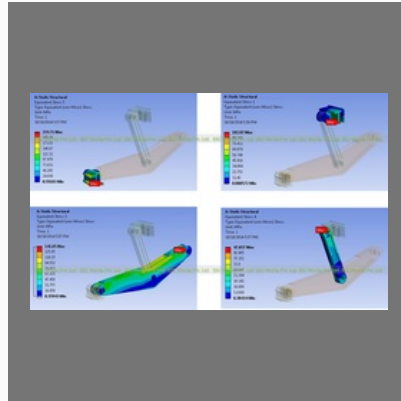

Vibration Analysis Services

# DRAWING SERVICES



Drafting Services

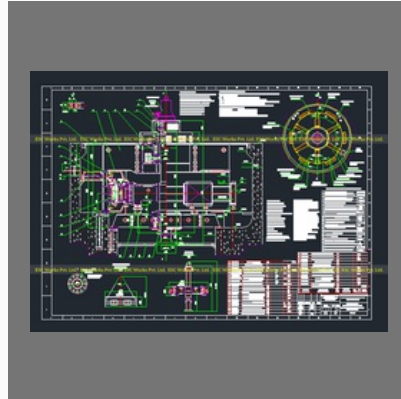

2D Drafting Services

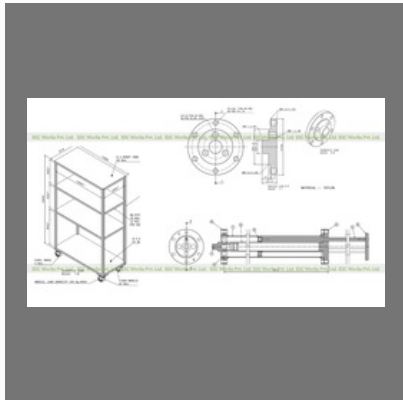

Drawing Job Work

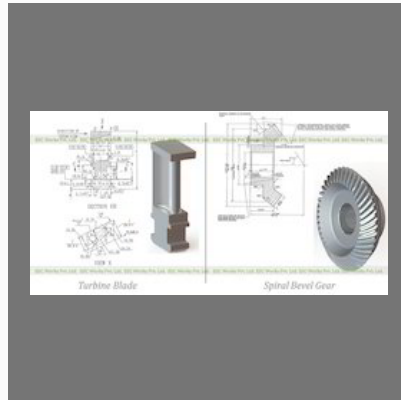

Engineering Drawing Services

# ANIMATION SERVICES



Machine Animation Services



3D Animation Services



3D Mechanical Animation Services



3D Walkthrough Services

# SOLID WORK LAYOUT SERVICES

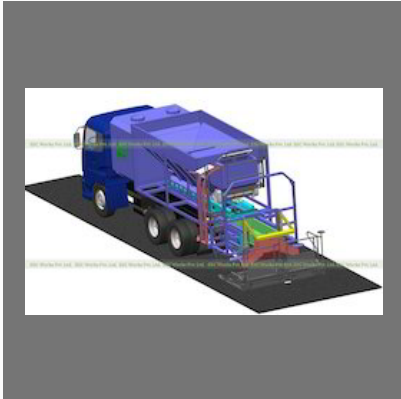

Solid Work CAD Service

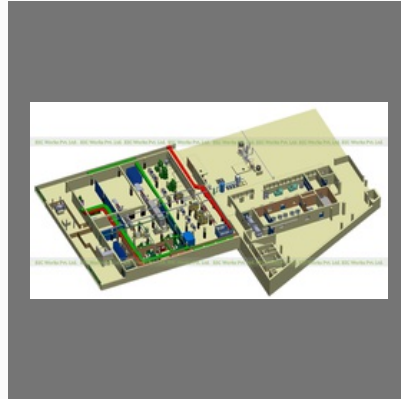

Solid Work 3D Layout Service

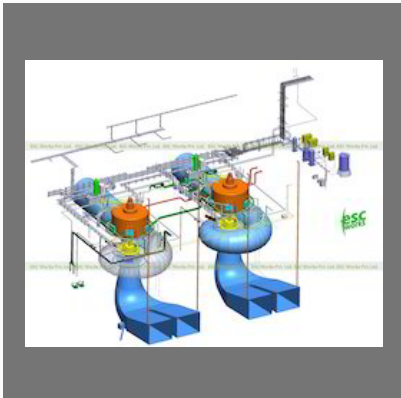

Solid Work Modelling Service



Solid Work Rendering Service



# AUTOCAD SERVICES

Our Services



Autocad Drawing Services

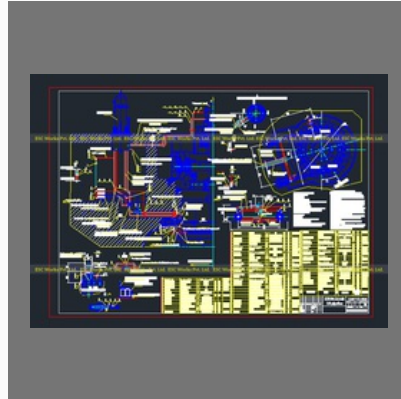

Autocad Drafting Services

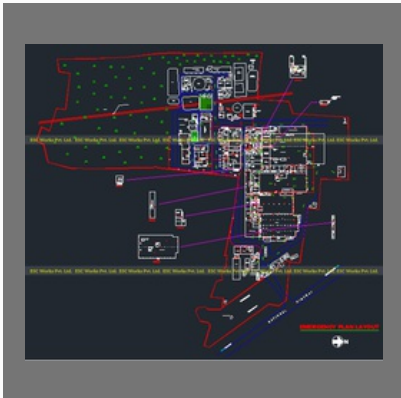

Autocad Layout Services

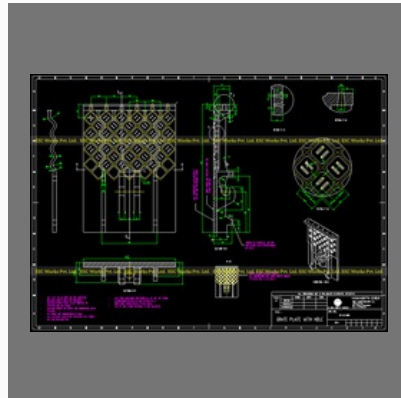

Autocad Job Work

# COMPUTATIONAL FLUID DYNAMICS ANALYSIS SERVICES

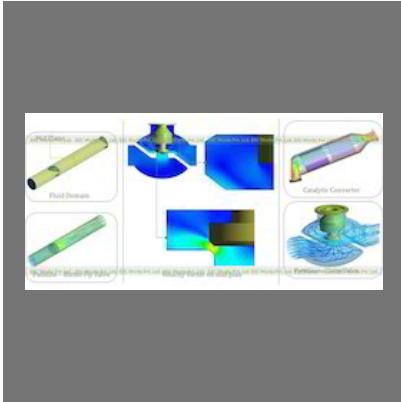

Computational Fluid Dynamics Services

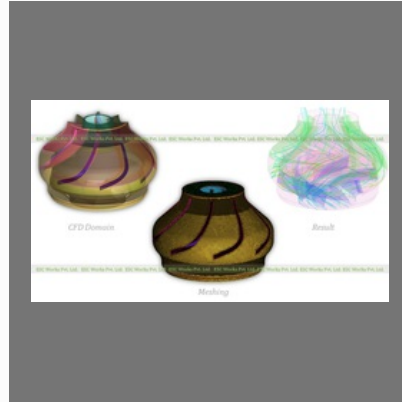

Pump Computational Fluid Dynamics Services

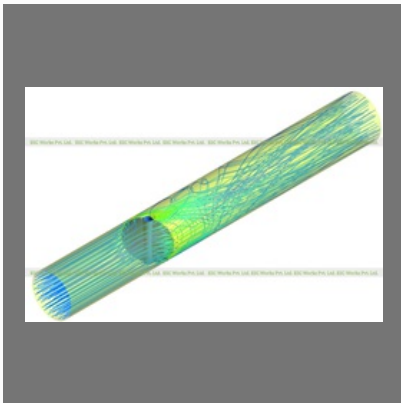

Transient Flow Analysis Services

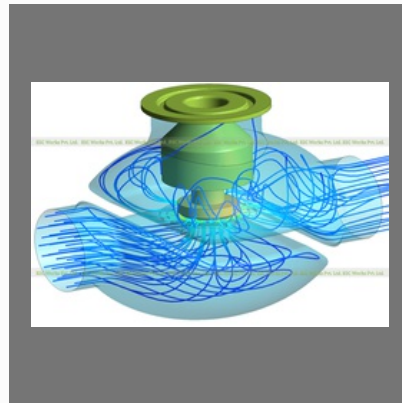

Valve Computational Fluid Dynamics Services

## OTHER SERVICES:

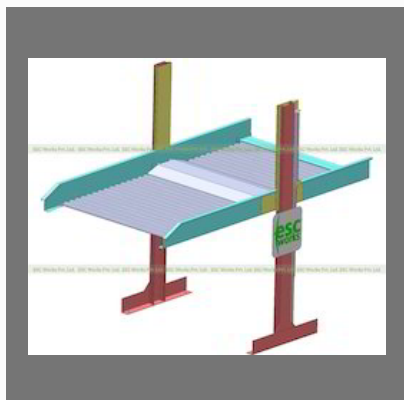

Product Development  
Consultant Service



CAD Services

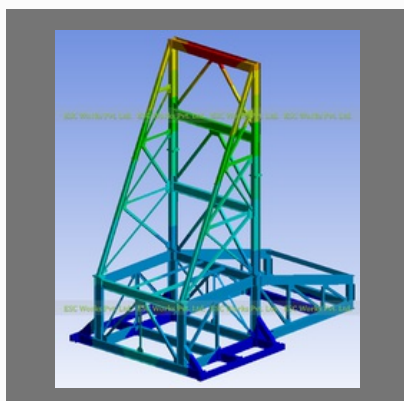

Linear Analysis Services

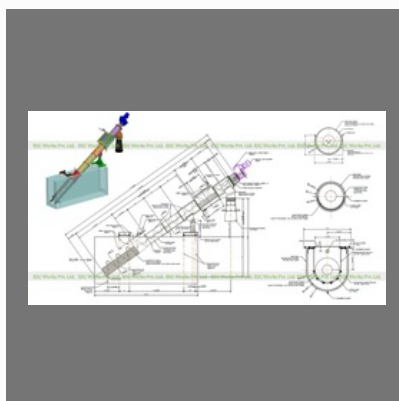

Manufacturing Drawing  
Services

## OTHER SERVICES:

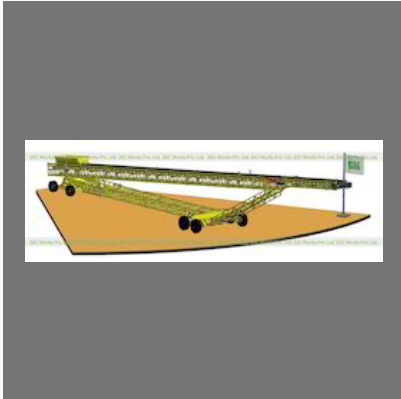

Solid Work Design Services

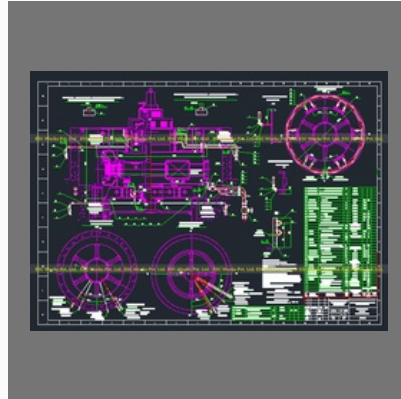

Autocad Design Services

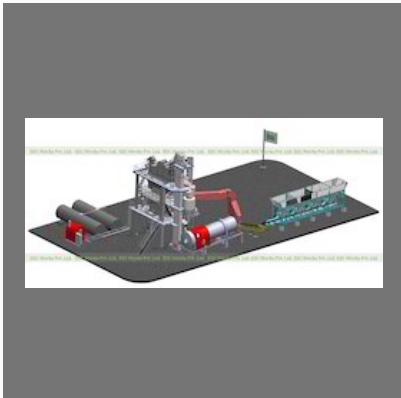

Reverse Engineering Services

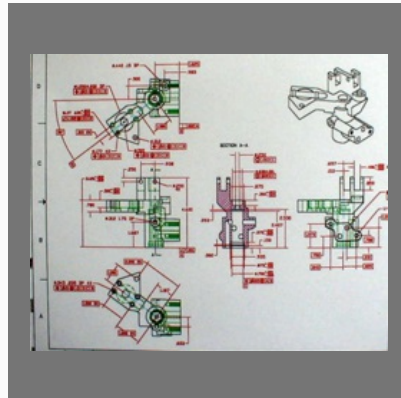

CAD Migration Services

# Factsheet

Year of Establishment : 2013

---

Nature of Business : Exporter and Service Provider

---

Total Number of Employees : 11 to 25 People

---



## CONTACT US

### **Esc Works Private Limited**

Contact Person: Sunil Prajapati

30, 3rd Floor, 4d Square Mall  
Ahmedabad - 380005, Gujarat, India



+91-8048006982



<https://www.indiamart.com/escworks/>