

G.M. Industries

<https://www.indiamart.com/gmindustries-delhi/>

We are manufacturer of **plastic mold,plastic compoinent mould,pressure die casting mold,pdc mould,high pressure die casting mold,zink casting ,zink mold,plastic brick mold,Industrial Moulds,plastic house hold product molds**



About Us

Founded in the year **2007**, **G.M. Industries** is one of the leading manufacturers, suppliers and traders of **Industrial Moulds, RO Parts, Water Filter Parts, PDC Casting, Solar Charge Controller, Pressure Die Casting Moulds , Plastic Component Moulds , etc.** Our product range includes **Aluminum Casting Die, Injection Moulding Machine, Pressure Die Casting Moulds, Membrane Housing, Inline Filter, Feeder Warmer etc.** These products are made by our professionals employing sophisticated technology and quality raw material that is sourced from genuine suppliers of industry. We have technological equipped manufacturing unit that gives better performances in manufacturing process. Our well-installed infrastructural facilities help us to supplying and trading these products as per the market and customers demands. Our talented professionals complete the needs and necessities of the customers in effective way. Apart from, we also supply these products as per the demands of our customers. Our quality analysts check the products on different quality parameters to assure flawless products from our end. Under the leadership of our highly experienced **Mr. Wasim Akram (Proprietor)**, our company has achieved vast achievement in this industry. His trade talent and vast knowledge have helped us to set a benchmark in this market.

For more information, please visit

<https://www.indiamart.com/gmindustries-delhi/profile.html>



INDUSTRIAL DIES AND MOULDS

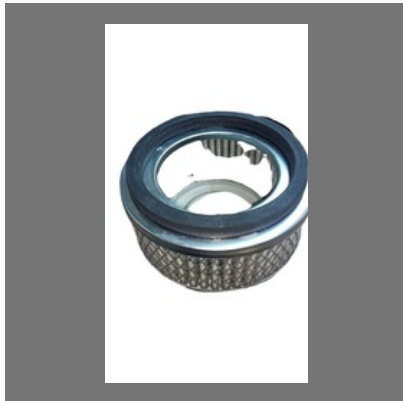

Air Filter

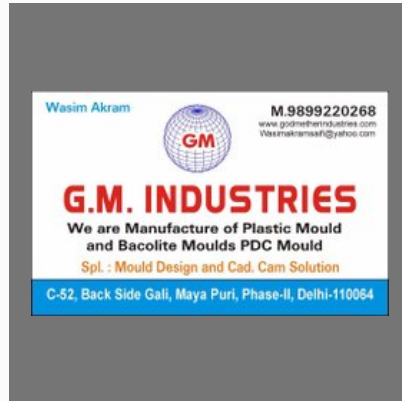

Respirator Filter Cap For Mask N95



injection molding mold

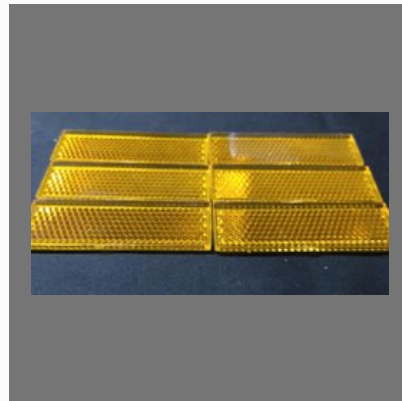

reflector for die mold

PLASTIC COMPONENT FABRICATION



Plastic Mold Die

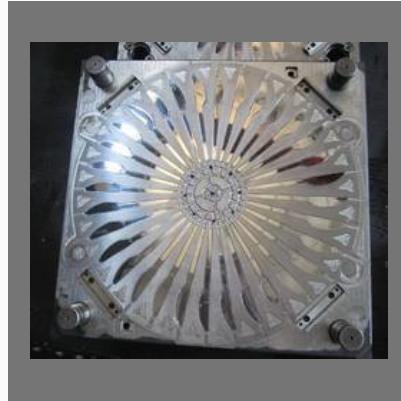

Plastic Tool And Dies



Mold for plastic component



Die Makers

RO PARTS



RO Pump Mold



Inline Filter



Pump Parts

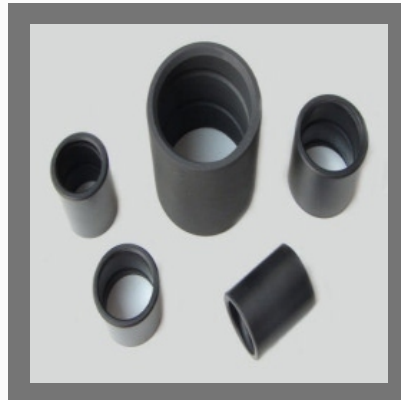

Pump Bearing Bush

BRICK MOULD



Safety Goggles Mold



plastic moulds manufacturers



Plastic Brick Molds

RUBBER PARTS



Rubber Part



Rubber Parts



Silicone Rubber Parts



Hook For Rubber Belt

RUBBER AUTOMOTIVE PARTS

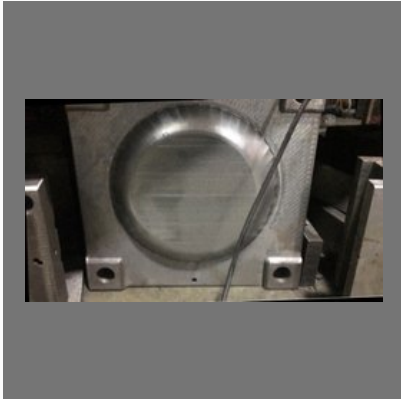

Plastic Cutlery Mold And Dies



Auto Rubber Parts



Automotive Rubber Products

PRESSURE DIE CASTING



Pressure Die Casting Mould



Camera Supply Cabinets



Die Maker

RO SMPS CABINETS



RO SMPS Cabinets



RO SMPS Cabinets



Ro Adopter Cabinet

OTHER PRODUCTS:



Plastic Crockery Mould



Molded Plastic Products



RO Smps Cabinet



PDC Mold

OTHER PRODUCTS:



Zinc Casting Mold



CCTV Camera Supply



LED Focus Light



Plastic Cap For Mask Filter

OTHER PRODUCTS:



Filter Cap



Membrane Housing



Membrane Housing



Safety Glass Mold For Covid19 Protection

OTHER PRODUCTS:



Disposable Safety Goggles



Solar Charger Cabinet



Aluminium Pressure Die Castings



Safety Goggles For Eye Protection

OTHER PRODUCTS:



plastic filter cap for mask



Steamer



Trophy Mold Die

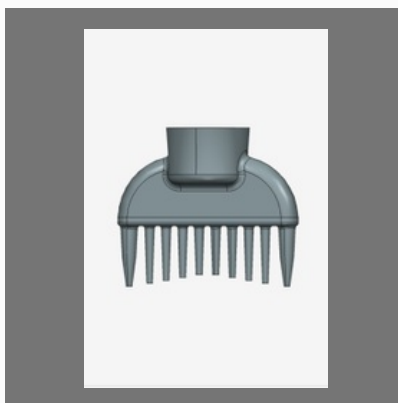

Comb Applicator Mold

OTHER PRODUCTS:



Brick Mold



Flip Top Caps Mold



Bottle Holder Mold For Hotel
And Home



Dog Mouth Basket

OTHER PRODUCTS:



Shower Parts Moulds



Moulding Rubber Parts



Sheet Metal



Brass Sheet Metal Component

OTHER PRODUCTS:



Aluminium part dies

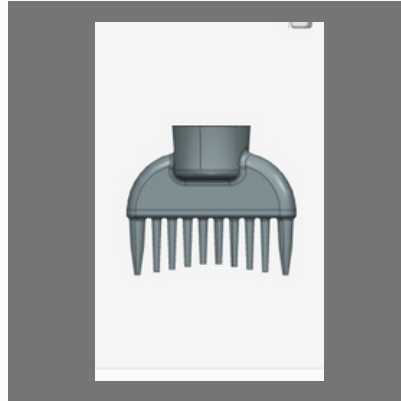

Comb Applicator Mold

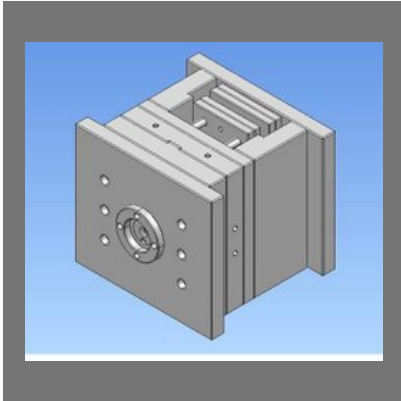

Mold Manufacturer Of Plastic Components

Factsheet

Year of Establishment : 2007

Nature of Business : Exporter and Manufacturer

Total Number of Employees : 11 to 25 People



CONTACT US

G.M. Industries

Contact Person: Wasim Akram Saifi

C-52, Phase 2

New Delhi - 110064, Delhi, India



+91-8048600756



<https://www.indiamart.com/gmindustries-delhi/>