



+91-8046042760

# Guru Nanak Machine Tools

<https://www.indiamart.com/guru-nanak-machine-tool/>

We GURU NANAK MACHINE TOOLS are engaged in manufacturing and supplying of quality range of industrial using equipments since 1982. The company stated giving excellent machine tools products in different states of Indian market.



## About Us

Founded in the year 1982, We "**Guru Nanak Machine Tools**" are engaged as a **Manufacturer, Supplier, Exporter, Distributor, Wholesaler and Trader** of **Power Chucks, Industrial Gears & Racks, GNMT Precision Vices** and much more. We provide these products and services in diverse specifications to attain the complete satisfaction of the client. Further, our strong support makes sure that these products are delivered within the promised time-frame. Under the supervision of **Mr. Dalvinder Singh (CEO)**, We have gained huge clientele in our country.

**For more information, please visit**

<https://www.indiamart.com/guru-nanak-machine-tool/profile.html>



# POWER CHUCKS



Unnat 2 Jaws 3 Jaws 4 Jaws  
Open Centre Power Chuck



MTM Self Centring True  
Chuck



Kitagawa Power Chuck B208



Airtech Face Clamping Power  
Chuck

## POWER CHUCK & CHUCK SPARES



Din Series Back Plate



Power Chuck Wedge



Lathe Chucks Pinion



Lathe Chuck Scroll Plate

# INDUSTRIAL GEARS & RACKS

Our Products



Cast Iron Helical Gears



Gunmetal Bronze Gear



Heavy Industry Ring Gears



Plastic Teflon Metlon Gears

## GNMT PRECISION VICES



GNMT Bench Vice



GNMT Compound Sliding Table



Drill Machine Vice



Milling Machine Vice

# LATHE MACHINE



Medium Duty Lathe Machine



Heavy Duty Lathe Machines



Lathe Machine Chucks



High Speed Small Lathe Machine

# LEAD SCREWS



Boring Machine Lead Screw  
Nut



Double Start Lead Screw



Heavy Industrial Lead Screw



Lathe Machine Lead Screws



## REVOLVING CENTER



Turnmax Revolving Center  
Slow Speed For Conventional  
Machines



Revolving Center Jumbo Extra  
Heavy Duty



Turnmax High Speed  
Revolving Center Small  
Casing Dia



R Model Turnmax Heavy Duty  
Revolving Center

# CNC LATHE TURRET BORING SLEEVE



CNC VMC Collet Adaptor ER Type Collet



Cylindrical Collet Chuck Holders

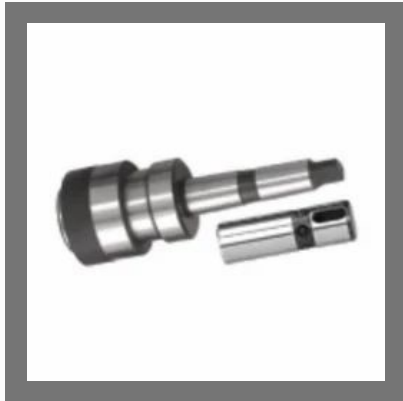

Quick Change Chuck Collets

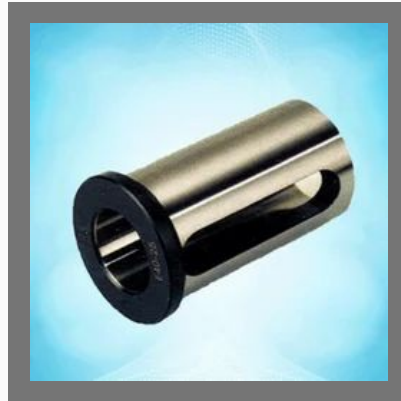

CNC Lathe Boring Bar Sleeve

# DRILL MACHINES



GNMT Bench Drill Machines



GNMT Extra Heavy Duty Drill Machines



GNMT Geared Precision Pillar Drill Machines



MITR Milling Machine With DRO

# BONET BONMAC INDEPENDENT DOG CHUCK



Bonet Extra Heavy Duty Independent Dog Chuck



Bonet Extra Light Duty Interdependent Chuck



Bonmac 4 Jaw Independent Dog Chuck



Bonmac And Bonet Big Bore 4 Jaws Independent Dog Chuck

# ROTARY CYLINDERS



Close Centre Rotary Cylinder



Seco Rotary Cylinders



Rotary Cylinder Open Center



Closed Centre Rotary Cylinder

# MAGNET CHUCK

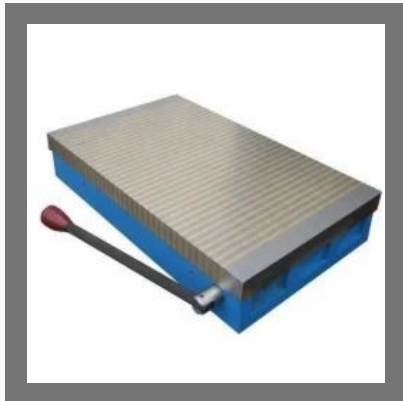

Fine Pole Magnet Chuck



Round Magnetic Chucks

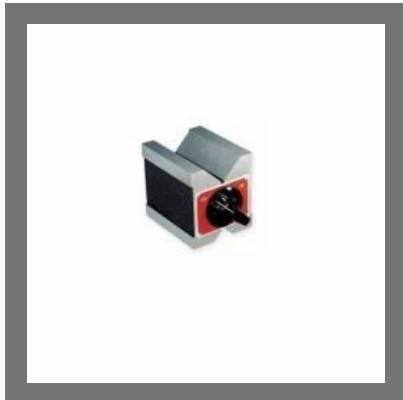

V Blocks Cast Iron Magnets

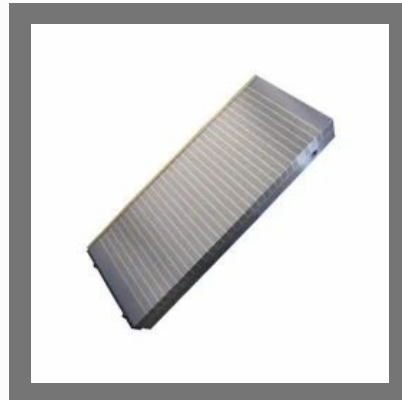

Through Pole Standard  
Magnetic Chuck

# DRILL CHUCK



Airtech Auto Indexing Power Chuck



Drill Chuck Key



Key Less Drill Chuck



Drill Chuck lathe taper handle

# KKF INDEPENDENT DOG CHUCK



KKF Independent Dog Chuck



KKF Special Long Jaws Chuck



KKF Big Bore Chucks



KKF Self Centering True Chuck



## SLIDING TABLES



Cross Slides Tables



T Slotted Heavy Duty  
Compound Slides

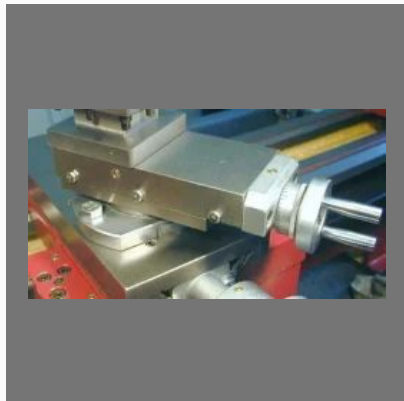

Stainless Steel Compound  
Slides

## DIVIDING HEADS



Silver Dividing Head



Manual Dividing Heads



Indexing Milling Fixtures  
Horizontal And Vertical

## ANGLE PLATES

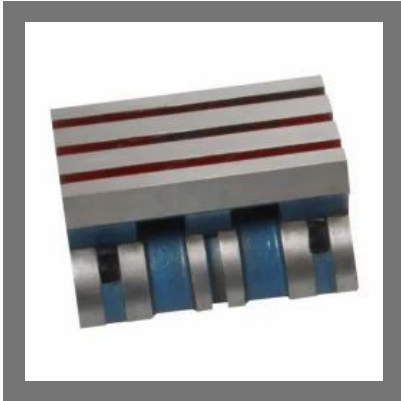

Adjustable Angle Plate

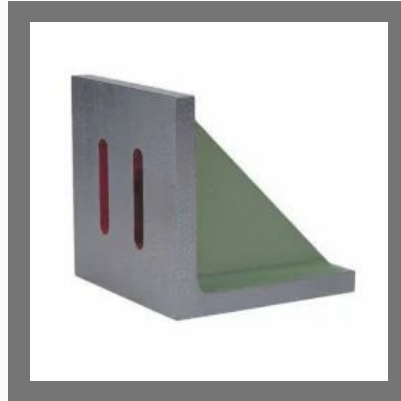

Cast Iron Angel Plain Plate

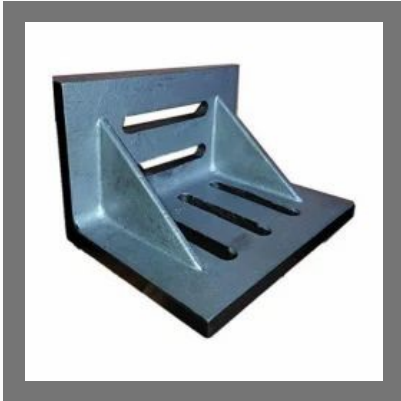

Cast Iron Slotted Angle  
Opened Plate

## OTHER PRODUCTS:



Airtech Pull Down Power Chuck



Six Jaws True Chucks



Inner Spline Gears



GNMT Precision Grinding Vice

## OTHER PRODUCTS:



Standard Lathe Machines



Planner Machine Lead Screw



Turn Max High Speed CNC  
Revolving Centre



CNC Boring Bar Sleeves

## OTHER PRODUCTS:



13mm Drilling Machine



Bonmac 2 and 4 Jaws Screw Operated Self Centering Chuck



Centre Rotary Cylinders



Hard Jaws CNC Chuck

## OTHER PRODUCTS:



Single Step Hard Jaws CNC Chuck

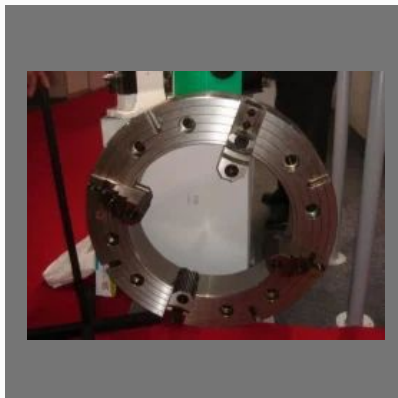

Seco Special Extra Large Bore Chuck



Seco Independent Chuck Detachable Jaws



Rotary Milling Table Horizontal

# Factsheet

Year of Establishment : 1982

---

Nature of Business : Exporter and Manufacturer

---

Total Number of Employees : Upto 10 People

---





## CONTACT US

### **Guru Nanak Machine Tools**

Contact Person: Gurpreet Singh

H-177, Sector 3 Bawana

New Delhi - 110039, Delhi, India



+91-8046042760



<https://www.indiamart.com/guru-nanak-machine-tool/>