



+91-7942634606

Jharna Process & Engineering Company

<https://www.indiamart.com/jharnaproces-engineering/>

Jharna Process and Engineering Company is an engineering and construction company renowned for working in various fields of Computational Fluid Dynamics, Industrial Solutions, Project Management Consultancy and Green Engineering.

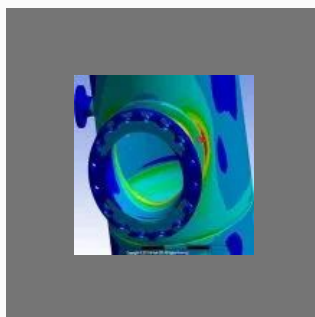

About Us

Jharna Process and Engineering Company is an engineering & manufacturing company renowned for working in various fields of Research, Process Engineering, Equipment Manufacturing and Electrical & Instrumentation Engineering in the heart of Delhi. Our company is named after and inspired by Late Smt. Jharna Guha in 2012. We believe our core values of integrity, client satisfaction, innovation and intellect differentiate us from our competitors.

For more information, please visit

<https://www.indiamart.com/jharnaproces-engineering/profile.html>



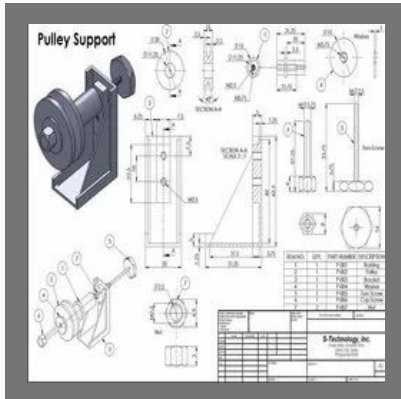

Detail Engineering Services



Piping Detail Engineering Services

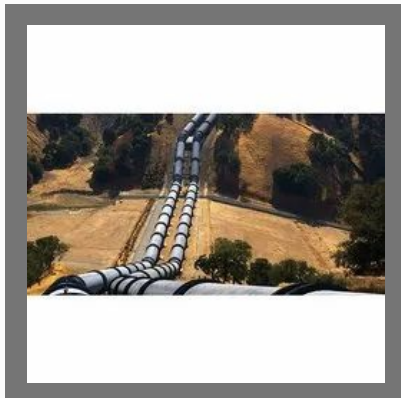

Pipeline Engineering

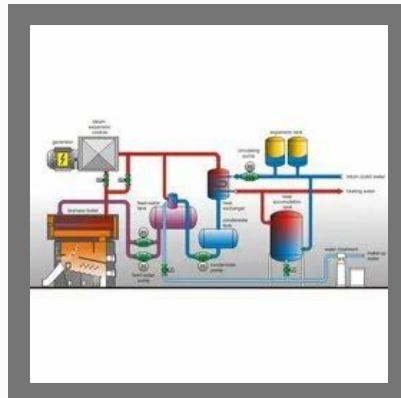

Process Engineering Service

ANALYSIS SERVICES

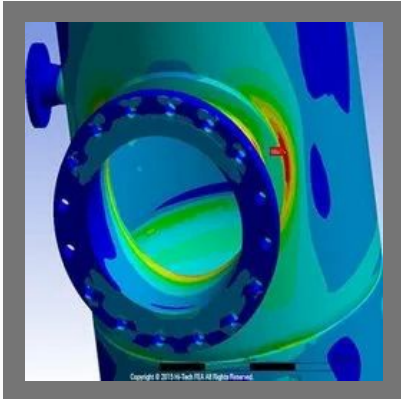

Finite Element Analysis Services

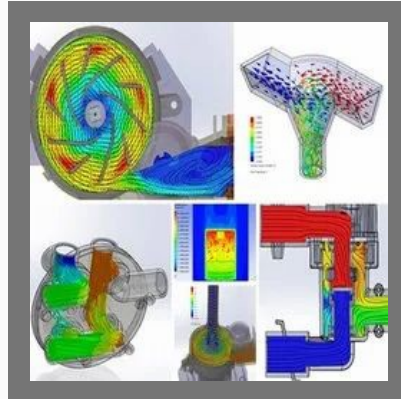

CFD Services



Pipe Stress Analysis

INDUSTRIAL SKIDS

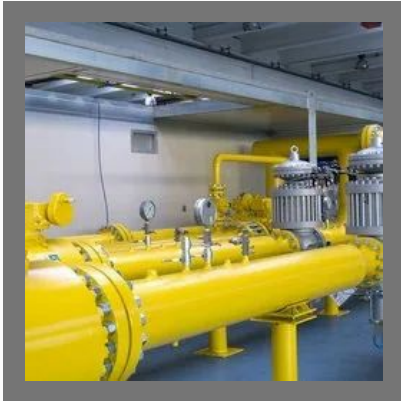

Pressure Reduction Skid



Chemical Injection Plant



Filtration Skid

OTHER PRODUCTS:



Air Cooled Heat Exchanger



Shell And Tube Heat Exchange



Air Dryer



Gas Dryer Package

OTHER PRODUCTS:



Nitrogen Gas Generators



IP Rating PLC Panel



Knock Out Drum

Factsheet

Year of Establishment : 2012

Nature of Business : Exporter and Manufacturer

Total Number of Employees : Upto 10 People



CONTACT US

Jharna Process & Engineering Company

Contact Person: JPEC Delhi

RZ-2042 Street No. 27

New Delhi - 110019, Delhi, India



+91-7942634606



<https://www.indiamart.com/jharnaproces-engineering/>